



Why do we use the hydraulic balancing valve

Hydraulic balance is necessary to avoid the following problems :

1. Some rooms almost never achieve the desired room temperature or are not cooled sufficiently. This problem especially arises in case of influence of other heat sources.
2. After changing over from low temperature to heating operation, it takes time to heat the parts in the system.
3. Indoor temperature changes, especially in the case of small demand, there is a greater possibility of this situation.
4. Consume more energy

It is unusual if the above problem happens.

Distribution of flow

If the drag in some parts of the piping is unbalanced, it will lead to unbalanced distribution of flow. The disposal to this problem is to install a Balance Valve in the piping and use a specific adjusted instrument to balance the drag in the system.

The illustration shows that the pump has to produce a differential pressure at least ΔP_{total} to guarantee a sufficient supply to appliance 4. This will, however, inevitably result in an excessive differential pressure at the appliances 1 to 3. Such high a differential pressure will cause overheat or under heat and a waste of energy.

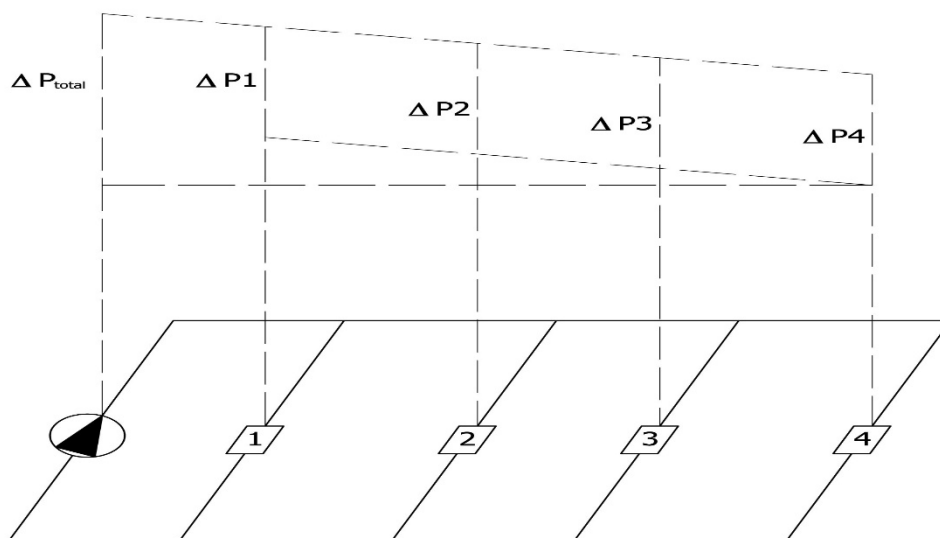

The principle of Balance Valve

The principle of balance is to adjust the gap between the core and the seat, for fluid flow through the valve, the gap changes the valve's resistance, and the flow rate will be adjusted. The balance valve equals to a local part, which resistance can be adjusted. For fluid can not be compressed, there is the flow rate formula.

$$Q = K_v \sqrt{\Delta P}$$

Q : Flow rate of fluid through the balance valve (m³/h)

Kv : The balance valve's resistance modulus, which can be adjusted.

ΔP : Different pressure before and behind the balance valve (bar)

Kv is a modulus of a balance valve. It means, if the differential pressure before and behind a balance valve is 1 bar (1.02 kg/cm²), the flow rate through the balance valve is Kv (m³/h) . And the valve's Kv will no changes if the open rate of the valve's core is not changed. That is, the opening rate of a balance valve determines the valve's Kv.

The balance valve can be used in following conditions

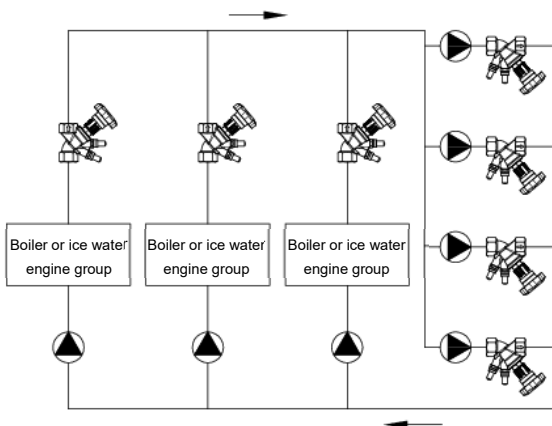

1. The balance of boiler or ice water engine group

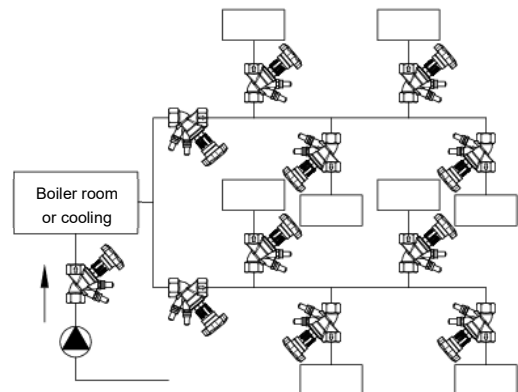

2. The balance of section's cooling or heating system

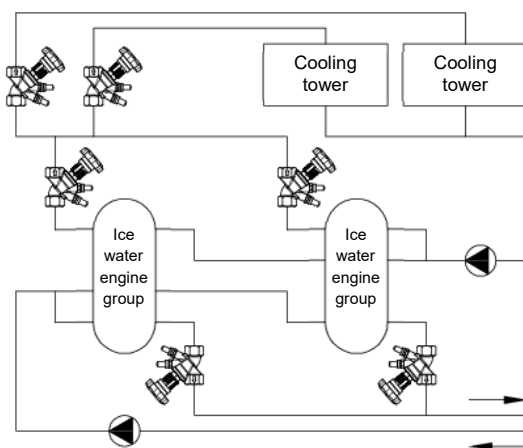

3. The balance between ice water engine group and cooling tower

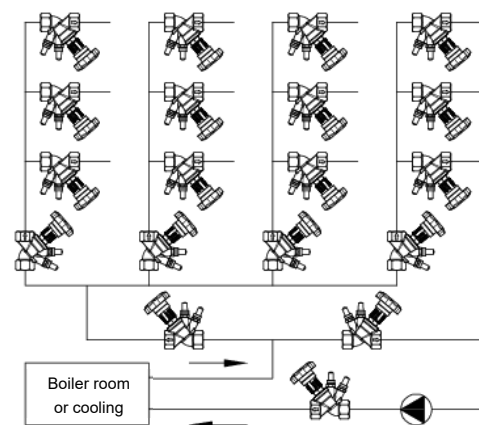

4. The balance of heating (or cooling) net in buildings

Dimension

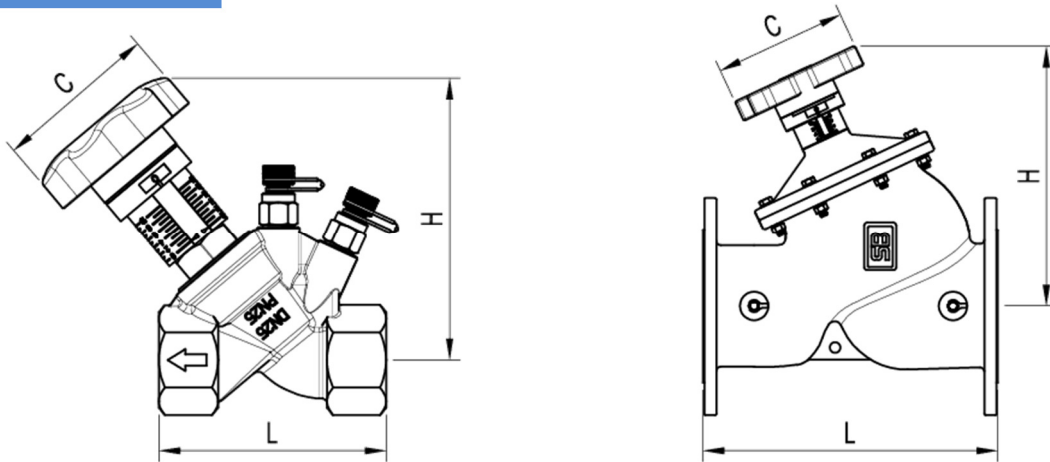

Size	Material	Connection	L (mm)	H (mm)	C (mm)
DN 20	Bronze	3/4" Thread	84	125	70
DN 25		1" Thread	96	125	70
DN 32		1-1/4" Thread	110	140	70
DN 40		1-1/2" Thread	120	145	70
DN 50		2" Thread	150	150	70
DN 65	Ductile Iron	2-1/2" Flange	229	285	210
DN 80		3" Flange	250	300	210
DN 100		4" Flange	320	330	210
DN 125		5" Flange	370	355	210
DN 150		6" Flange	415	370	210
DN 200		8" Flange	500	500	300
DN 250		10" Flange	605	540	300
DN 300		12" Flange	725	560	300
DN 350		14" Flange	733	655	300
DN 400		16" Flange	990	825	540
DN 450		18" Flange	1000	845	540
DN 500		20" Flange	1100	920	540

※King-Tech reserves the right to make any revisions on the valve model and size without prior notification.

※When making any design drawing, installation drawing or construction drawing, please do get our approved CAD with our signature, or we will not be responsible for any mistake.

Tolerance Chart

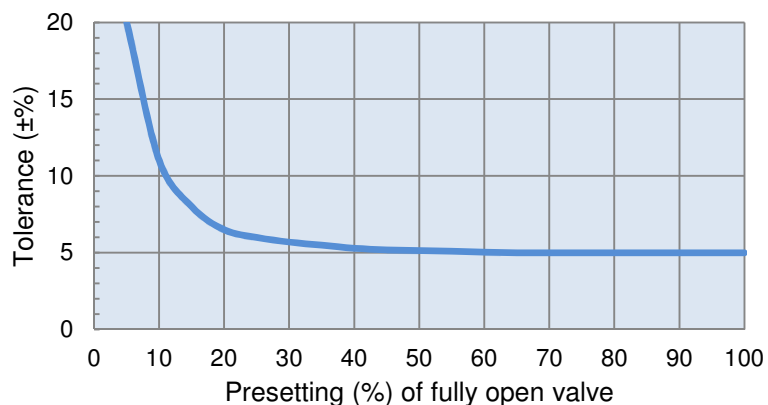

Specification

Class	10K / 150LB / PN10	16K / PN16	PN25
Working Pressure	10 bar	16 bar	25 bar
Temperature	-10~100 °C	-10~100 °C	-10~100 °C

※The SB balancing valves have memory part, and the turns of hand wheel can be easily turned back to originally position

Kv Curves

DN 20			
Presetting	Kv	Presetting	Kv
0.5	0.38	4.1	2.77
1.0	0.68	4.2	2.85
1.1	0.85	4.3	2.94
1.2	0.91	4.4	3.12
1.3	0.93	4.5	3.18
1.4	0.99	4.6	3.25
1.5	1.06	4.7	3.41
1.6	1.10	4.8	3.52
1.7	1.15	4.9	3.63
1.8	1.17	5.0	3.74
1.9	1.20	5.1	3.85
2.0	1.20	5.2	3.95
2.1	1.22	5.3	4.05
2.2	1.25	5.4	4.13
2.3	1.29	5.5	4.20
2.4	1.33	5.6	4.25
2.5	1.36	5.7	4.31
2.6	1.44	5.8	4.40
2.7	1.53	5.9	4.46
2.8	1.56	6.0	4.54
2.9	1.60	6.1	4.61
3.0	1.66	6.2	4.68
3.1	1.72	6.3	4.80
3.2	1.77	6.4	4.89
3.3	1.84	6.5	4.97
3.4	1.93	6.6	5.04
3.5	2.11	6.7	5.11
3.6	2.17	6.8	5.22
3.7	2.29	6.9	5.31
3.8	2.39	7.0	5.37
3.9	2.56		
4.0	2.67		

DN 25			
Presetting	Kv	Presetting	Kv
0.5	1.10	4.1	5.49
1.0	1.83	4.2	5.63
1.1	2.00	4.3	5.80
1.2	2.18	4.4	6.01
1.3	2.31	4.5	6.22
1.4	2.37	4.6	6.37
1.5	2.53	4.7	6.52
1.6	2.59	4.8	6.63
1.7	2.66	4.9	6.75
1.8	2.74	5.0	6.97
1.9	2.82	5.1	7.06
2.0	2.91	5.2	7.18
2.1	2.98	5.3	7.31
2.2	3.06	5.4	7.46
2.3	3.16	5.5	7.57
2.4	3.26	5.6	7.67
2.5	3.34	5.7	7.76
2.6	3.43	5.8	7.88
2.7	3.52	5.9	7.97
2.8	3.62	6.0	8.06
2.9	3.71	6.1	8.23
3.0	3.80	6.2	8.34
3.1	3.93	6.3	8.43
3.2	4.03	6.4	8.55
3.3	4.18	6.5	8.62
3.4	4.31	6.6	8.68
3.5	4.57	6.7	8.73
3.6	4.68	6.8	8.86
3.7	4.81	6.9	8.95
3.8	4.94	7.0	9.11
3.9	5.19		
4.0	5.34		

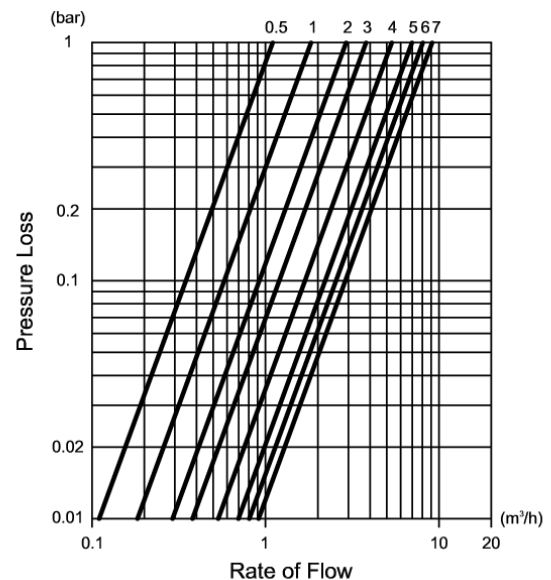
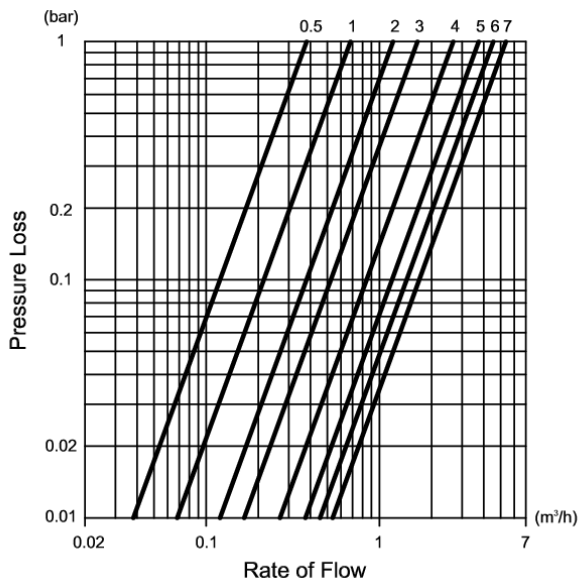

DN 32			
Presetting	Kv	Presetting	Kv
0.5	1.20	5.5	10.11
1.0	2.49	5.6	10.24
1.1	2.52	5.7	10.45
1.2	2.69	5.8	10.52
1.3	2.92	5.9	10.70
1.4	3.19	6.0	11.02
1.5	3.47	6.1	10.99
1.6	3.59	6.2	11.19
1.7	3.71	6.3	11.26
1.8	3.84	6.4	11.37
1.9	4.02	6.5	11.50
2.0	4.23	6.6	11.61
2.1	4.43	6.7	11.66
2.2	4.61	6.8	11.73
2.3	4.78	6.9	11.81
2.4	4.95	7.0	12.04
2.5	5.30	7.1	12.22
2.6	5.48	7.2	12.35
2.7	5.62	7.3	12.51
2.8	5.92	7.4	12.65
2.9	6.08	7.5	12.81
3.0	6.22	7.6	13.02
3.1	6.40	7.7	13.10
3.2	6.67	7.8	13.15
3.3	6.79	7.9	13.21
3.4	6.90	8.0	13.29
3.5	7.08	8.1	13.36
3.6	7.28	8.2	13.43
3.7	7.42	8.3	13.49
3.8	7.68	8.4	13.57
3.9	7.84	8.5	13.70
4.0	8.00	8.6	13.78
4.1	8.14	8.7	13.81
4.2	8.27	8.8	13.86
4.3	8.40	8.9	13.91
4.4	8.51	9.0	13.96
4.5	8.61	9.1	14.06
4.6	8.80	9.2	14.12
4.7	8.92	9.3	14.19
4.8	9.04	9.4	14.29
4.9	9.16	9.5	14.42
5.0	9.27	9.6	14.51
5.1	9.61	9.7	14.60
5.2	9.67	9.8	14.67
5.3	9.84	9.9	14.84
5.4	9.94	10.0	14.94

DN 40			
Presetting	Kv	Presetting	Kv
0.5	0.96	5.5	14.57
1.0	2.38	5.6	14.74
1.1	2.67	5.7	14.98
1.2	3.02	5.8	15.24
1.3	3.29	5.9	15.53
1.4	3.59	6.0	15.72
1.5	3.86	6.1	16.04
1.6	4.10	6.2	16.18
1.7	4.48	6.3	16.24
1.8	4.81	6.4	16.32
1.9	5.18	6.5	16.38
2.0	5.29	6.6	16.46
2.1	5.47	6.7	16.54
2.2	5.68	6.8	16.70
2.3	5.90	6.9	16.81
2.4	6.18	7.0	16.91
2.5	6.45	7.1	17.02
2.6	6.79	7.2	17.10
2.7	7.30	7.3	17.24
2.8	7.62	7.4	17.28
2.9	7.98	7.5	17.42
3.0	8.20	7.6	17.51
3.1	8.61	7.7	17.66
3.2	8.87	7.8	17.76
3.3	9.23	7.9	17.96
3.4	9.51	8.0	18.03
3.5	9.77	8.1	18.21
3.6	10.22	8.2	18.31
3.7	10.68	8.3	18.40
3.8	10.86	8.4	18.59
3.9	11.15	8.5	18.82
4.0	11.39	8.6	19.00
4.1	11.53	8.7	19.19
4.2	11.59	8.8	19.29
4.3	11.69	8.9	19.46
4.4	11.77	9.0	19.62
4.5	12.04	9.1	19.71
4.6	12.29	9.2	19.76
4.7	12.56	9.3	19.89
4.8	12.89	9.4	19.96
4.9	13.25	9.5	20.15
5.0	13.44	9.6	20.26
5.1	13.74	9.7	20.36
5.2	13.92	9.8	20.45
5.3	14.16	9.9	20.58
5.4	14.44	10.0	20.72

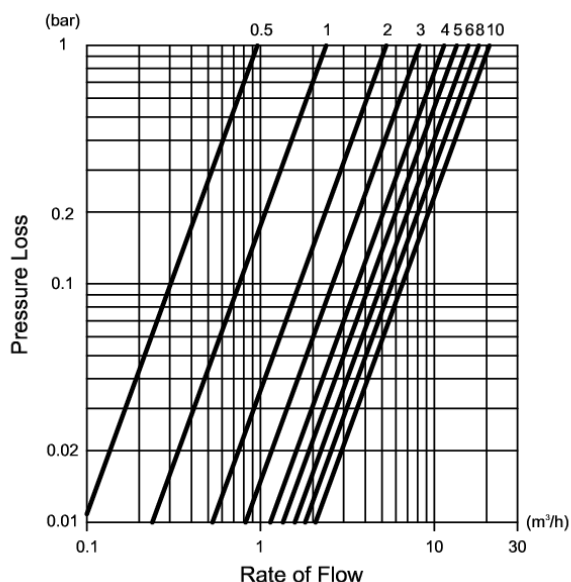
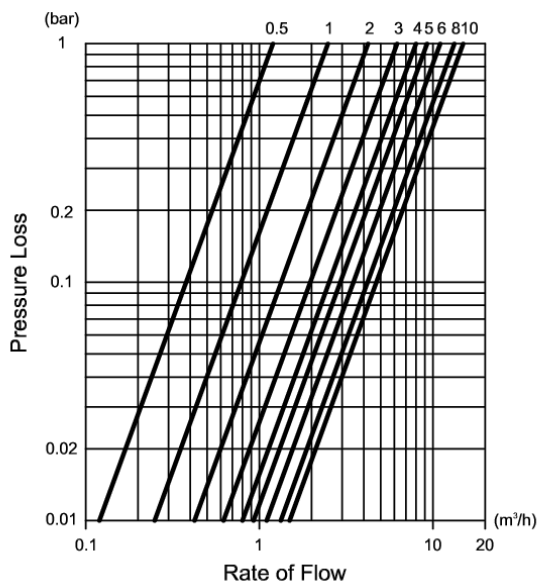

DN 50			
Presetting	Kv	Presetting	Kv
0.5	3.10	5.5	27.42
1.0	5.61	5.6	27.80
1.1	6.01	5.7	28.24
1.2	6.32	5.8	28.52
1.3	6.74	5.9	28.90
1.4	7.13	6.0	29.03
1.5	7.51	6.1	29.32
1.6	8.01	6.2	29.53
1.7	8.46	6.3	29.69
1.8	8.93	6.4	29.90
1.9	9.42	6.5	30.03
2.0	9.81	6.6	30.27
2.1	10.28	6.7	30.53
2.2	10.52	6.8	30.77
2.3	10.92	6.9	31.00
2.4	11.39	7.0	31.23
2.5	11.80	7.1	31.95
2.6	12.20	7.2	32.10
2.7	12.78	7.3	32.28
2.8	13.31	7.4	32.33
2.9	13.72	7.5	32.43
3.0	14.35	7.6	32.75
3.1	14.83	7.7	32.97
3.2	15.25	7.8	33.19
3.3	15.76	7.9	33.46
3.4	16.16	8.0	33.54
3.5	16.71	8.1	33.73
3.6	17.23	8.2	33.57
3.7	17.85	8.3	33.88
3.8	18.43	8.4	33.95
3.9	19.07	8.5	34.08
4.0	19.82	8.6	34.35
4.1	20.46	8.7	34.59
4.2	20.97	8.8	34.65
4.3	21.48	8.9	34.87
4.4	22.12	9.0	34.93
4.5	22.56	9.1	35.07
4.6	23.00	9.2	35.19
4.7	23.68	9.3	35.35
4.8	24.24	9.4	35.43
4.9	24.82	9.5	35.66
5.0	25.67	9.6	35.68
5.1	26.41	9.7	35.71
5.2	26.56	9.8	35.77
5.3	26.71	9.9	35.82
5.4	27.05	10.0	35.85

DN 65			
Presetting	Kv	Presetting	Kv
1.0	6.74	5.6	45.86
1.1	6.92	5.7	47.17
1.2	7.11	5.8	48.64
1.3	7.36	5.9	50.10
1.4	7.60	6.0	51.90
1.5	7.91	6.1	53.74
1.6	8.46	6.2	55.15
1.7	9.12	6.3	56.40
1.8	10.00	6.4	57.95
1.9	10.65	6.5	59.13
2.0	11.28	6.6	60.38
2.1	12.31	6.7	61.02
2.2	12.95	6.8	61.76
2.3	13.57	6.9	62.59
2.4	14.24	7.0	63.28
2.5	14.96	7.1	64.27
2.6	15.67	7.2	65.27
2.7	16.30	7.3	66.23
2.8	17.02	7.4	67.14
2.9	17.72	7.5	68.06
3.0	18.40	7.6	68.74
3.1	19.14	7.7	69.34
3.2	19.81	7.8	70.18
3.3	20.47	7.9	71.05
3.4	21.39	8.0	71.53
3.5	22.22		
3.6	22.94		
3.7	23.70		
3.8	24.63		
3.9	25.59		
4.0	26.51		
4.1	27.54		
4.2	28.65		
4.3	29.80		
4.4	30.97		
4.5	32.12		
4.6	33.61		
4.7	34.73		
4.8	36.16		
4.9	37.29		
5.0	38.39		
5.1	39.50		
5.2	40.47		
5.3	41.57		
5.4	43.10		
5.5	44.42		

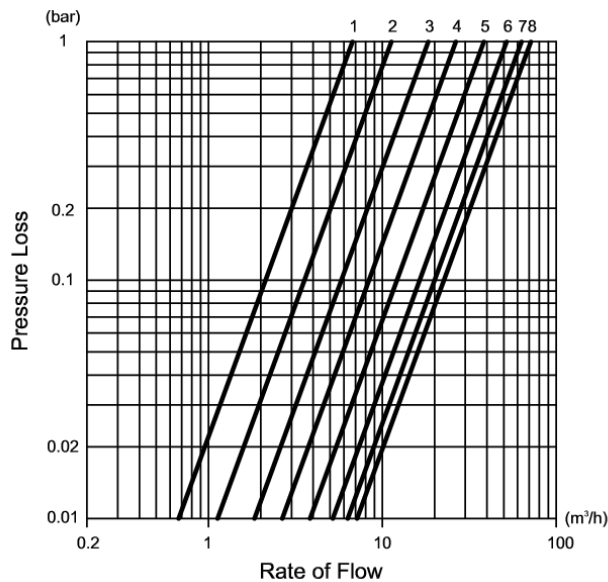
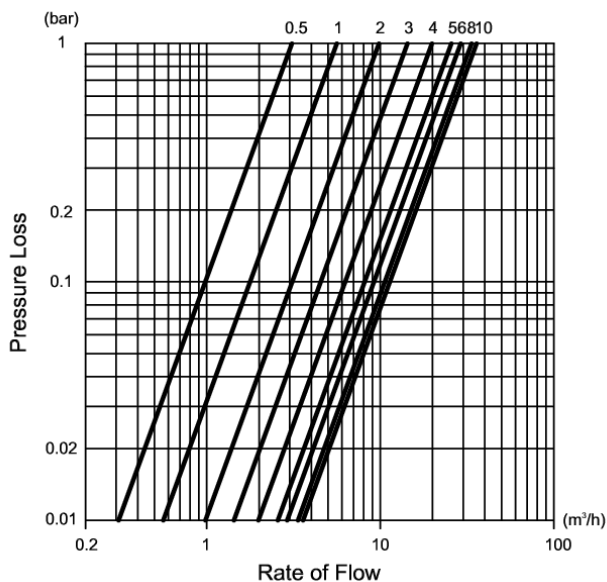

DN 80			
Presetting	Kv	Presetting	Kv
1.0	8.86	4.6	53.14
1.1	9.15	4.7	54.94
1.2	9.83	4.8	56.70
1.3	10.85	4.9	58.51
1.4	11.87	5.0	60.34
1.5	12.86	5.1	62.09
1.6	14.08	5.2	63.80
1.7	15.32	5.3	65.64
1.8	16.49	5.4	67.54
1.9	17.64	5.5	69.09
2.0	18.72	5.6	70.62
2.1	20.22	5.7	72.25
2.2	21.34	5.8	73.75
2.3	22.43	5.9	74.85
2.4	23.58	6.0	76.08
2.5	24.66	6.1	77.38
2.6	25.75	6.2	78.57
2.7	26.81	6.3	79.45
2.8	27.85	6.4	80.46
2.9	28.94	6.5	81.60
3.0	29.92	6.6	82.69
3.1	31.02	6.7	83.73
3.2	32.25	6.8	84.59
3.3	33.33	6.9	85.47
3.4	34.49	7.0	86.37
3.5	35.68	7.1	86.95
3.6	37.06	7.2	88.03
3.7	38.47	7.3	88.90
3.8	39.94	7.4	89.79
3.9	41.47	7.5	90.58
4.0	43.06	7.6	91.25
4.1	44.91	7.7	92.21
4.2	46.37	7.8	93.35
4.3	48.08	7.9	94.24
4.4	49.80	8.0	94.84
4.5	51.46		

DN 100			
Presetting	Kv	Presetting	Kv
1.0	9.58	4.6	93.52
1.1	10.57	4.7	97.10
1.2	11.83	4.8	100.68
1.3	13.40	4.9	104.44
1.4	15.17	5.0	108.16
1.5	16.82	5.1	112.07
1.6	18.60	5.2	115.16
1.7	20.37	5.3	119.20
1.8	22.17	5.4	122.76
1.9	24.22	5.5	126.50
2.0	26.19	5.6	129.85
2.1	28.09	5.7	135.01
2.2	29.94	5.8	139.52
2.3	31.60	5.9	143.26
2.4	33.42	6.0	146.22
2.5	35.01	6.1	146.70
2.6	36.48	6.2	148.60
2.7	38.18	6.3	151.08
2.8	39.92	6.4	155.19
2.9	41.67	6.5	158.85
3.0	43.57	6.6	161.49
3.1	45.82	6.7	163.27
3.2	48.14	6.8	164.53
3.3	50.73	6.9	165.61
3.4	53.98	7.0	166.85
3.5	56.52	7.1	168.50
3.6	59.53	7.2	170.51
3.7	62.66	7.3	172.72
3.8	65.82	7.4	174.98
3.9	69.02	7.5	177.15
4.0	72.62	7.6	179.13
4.1	76.11	7.7	180.91
4.2	79.45	7.8	182.56
4.3	82.36	7.9	184.11
4.4	85.93	8.0	185.61
4.5	90.04		

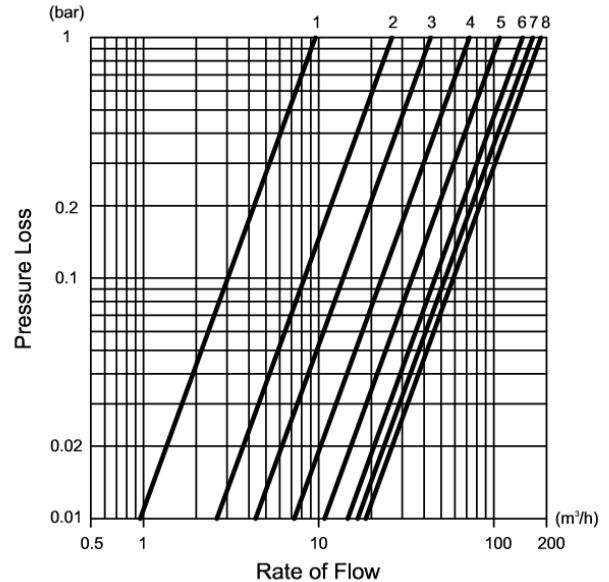
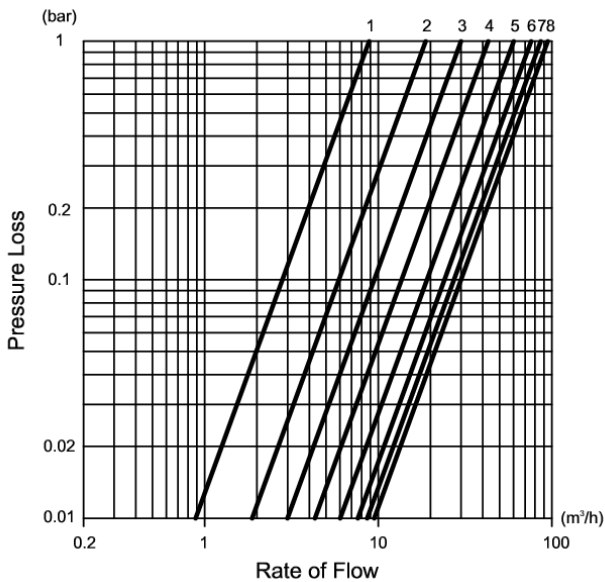

DN 125			
Presetting	Kv	Presetting	Kv
1.0	22.56	4.6	160.59
1.1	25.22	4.7	164.84
1.2	27.95	4.8	169.13
1.3	31.45	4.9	173.68
1.4	34.90	5.0	178.63
1.5	37.72	5.1	183.91
1.6	40.51	5.2	189.35
1.7	43.39	5.3	194.79
1.8	46.22	5.4	200.02
1.9	48.94	5.5	204.81
2.0	51.77	5.6	209.03
2.1	54.42	5.7	212.88
2.2	57.28	5.8	216.70
2.3	60.33	5.9	220.74
2.4	62.98	6.0	225.04
2.5	63.71	6.1	229.58
2.6	70.03	6.2	234.30
2.7	71.42	6.3	239.08
2.8	75.58	6.4	243.73
2.9	77.89	6.5	248.12
3.0	81.46	6.6	252.09
3.1	85.69	6.7	255.43
3.2	90.10	6.8	258.10
3.3	94.65	6.9	260.44
3.4	99.38	7.0	262.87
3.5	104.33	7.1	265.70
3.6	109.39	7.2	268.65
3.7	114.40	7.3	271.32
3.8	119.29	7.4	273.45
3.9	124.22	7.5	275.43
4.0	129.42	7.6	277.81
4.1	135.03	7.7	281.01
4.2	140.79	7.8	284.91
4.3	146.36	7.9	289.30
4.4	151.48	8.0	293.92
4.5	156.18		

DN 150			
Presetting	Kv	Presetting	Kv
1.0	13.34	4.6	190.11
1.1	16.78	4.7	198.01
1.2	20.14	4.8	207.19
1.3	24.01	4.9	215.37
1.4	27.80	5.0	223.81
1.5	31.11	5.1	235.41
1.6	35.24	5.2	244.11
1.7	38.84	5.3	252.88
1.8	42.68	5.4	261.50
1.9	45.70	5.5	269.69
2.0	48.48	5.6	277.22
2.1	51.69	5.7	284.10
2.2	54.64	5.8	290.36
2.3	57.86	5.9	296.12
2.4	61.87	6.0	301.67
2.5	64.78	6.1	307.36
2.6	68.08	6.2	313.45
2.7	71.54	6.3	319.77
2.8	75.05	6.4	326.10
2.9	78.64	6.5	332.19
3.0	82.36	6.6	337.88
3.1	86.18	6.7	343.02
3.2	90.19	6.8	347.52
3.3	94.44	6.9	351.49
3.4	99.82	7.0	355.09
3.5	104.94	7.1	358.51
3.6	115.60	7.2	361.99
3.7	123.20	7.3	365.81
3.8	130.50	7.4	370.11
3.9	138.35	7.5	374.55
4.0	145.50	7.6	378.65
4.1	152.98	7.7	382.06
4.2	159.80	7.8	384.86
4.3	167.89	7.9	387.26
4.4	174.83	8.0	389.46
4.5	182.33		

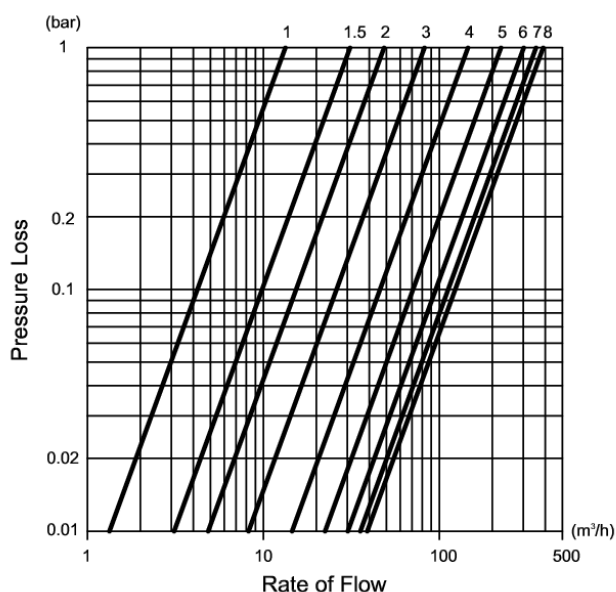
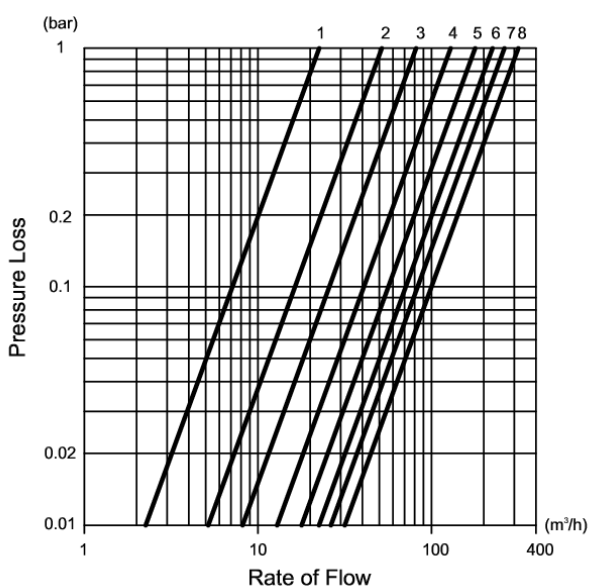

DN 200					
Presetting	Kv	Presetting	Kv	Presetting	Kv
1.0	11.78	4.7	132.71	8.4	326.24
1.1	11.84	4.8	137.92	8.5	331.13
1.2	11.93	4.9	143.24	8.6	336.43
1.3	12.30	5.0	148.63	8.7	342.05
1.4	12.74	5.1	154.12	8.8	347.86
1.5	13.15	5.2	159.63	8.9	353.71
1.6	14.33	5.3	165.17	9.0	359.46
1.7	15.92	5.4	170.67	9.1	365.00
1.8	17.92	5.5	176.10	9.2	370.37
1.9	20.31	5.6	181.47	9.3	375.63
2.0	23.08	5.7	186.80	9.4	380.86
2.1	26.24	5.8	192.21	9.5	386.12
2.2	29.70	5.9	197.78	9.6	391.48
2.3	35.24	6.0	203.59	9.7	396.93
2.4	37.38	6.1	209.68	9.8	402.44
2.5	41.48	6.2	215.94	9.9	407.97
2.6	45.68	6.3	222.18	10.0	413.53
2.7	49.89	6.4	228.27	10.1	419.08
2.8	54.01	6.5	234.03	10.2	424.56
2.9	57.97	6.6	239.34	10.3	429.92
3.0	61.66	6.7	244.25	10.4	435.11
3.1	65.03	6.8	248.86	10.5	440.05
3.2	68.21	6.9	253.28	10.6	444.72
3.3	71.34	7.0	257.60	10.7	449.20
3.4	74.56	7.1	261.91	10.8	453.56
3.5	78.03	7.2	266.29	10.9	457.92
3.6	81.86	7.3	270.82	11.0	462.36
3.7	86.00	7.4	275.55	11.1	466.97
3.8	90.37	7.5	280.58	11.2	471.68
3.9	94.88	7.6	285.93	11.3	476.45
4.0	99.45	7.7	291.48	11.4	481.22
4.1	104.01	7.8	297.08	11.5	485.92
4.2	108.58	7.9	302.55	11.6	490.51
4.3	113.19	8.0	307.75	11.7	495.00
4.4	117.88	8.1	312.58	11.8	499.41
4.5	122.69	8.2	317.14	11.9	503.77
4.6	127.64	8.3	321.64	12.0	508.11

DN 250					
Presetting	Kv	Presetting	Kv	Presetting	Kv
1.0	13.96	4.7	234.09	8.4	558.11
1.1	14.05	4.8	240.65	8.5	571.42
1.2	14.56	4.9	247.13	8.6	585.29
1.3	14.98	5.0	253.50	8.7	599.35
1.4	15.50	5.1	259.78	8.8	613.09
1.5	15.90	5.2	266.04	8.9	626.02
1.6	19.94	5.3	272.39	9.0	637.66
1.7	25.21	5.4	278.92	9.1	647.69
1.8	31.23	5.5	285.73	9.2	656.56
1.9	37.51	5.6	292.89	9.3	664.90
2.0	43.56	5.7	300.27	9.4	673.36
2.1	49.06	5.8	307.73	9.5	682.56
2.2	54.34	5.9	315.11	9.6	692.95
2.3	59.89	6.0	322.26	9.7	704.23
2.4	66.22	6.1	329.10	9.8	715.90
2.5	73.82	6.2	335.80	9.9	727.47
2.6	82.99	6.3	342.65	10.0	738.44
2.7	93.21	6.4	349.88	10.1	748.49
2.8	103.80	6.5	357.77	10.2	757.92
2.9	114.02	6.6	366.49	10.3	767.19
3.0	123.18	6.7	375.90	10.4	776.77
3.1	130.76	6.8	385.77	10.5	787.13
3.2	137.06	6.9	395.88	10.6	798.58
3.3	142.56	7.0	406.01	10.7	810.84
3.4	147.75	7.1	415.98	10.8	823.48
3.5	153.11	7.2	425.84	10.9	836.07
3.6	159.03	7.3	435.67	11.0	848.19
3.7	165.46	7.4	445.58	11.1	859.50
3.8	172.26	7.5	455.66	11.2	870.00
3.9	179.27	7.6	465.99	11.3	879.81
4.0	186.35	7.7	476.57	11.4	889.04
4.1	193.37	7.8	487.40	11.5	897.79
4.2	200.31	7.9	498.46	11.6	906.17
4.3	207.19	8.0	509.76	11.7	914.25
4.4	214.00	8.1	521.29	11.8	922.11
4.5	220.75	8.2	533.13	11.9	929.82
4.6	227.45	8.3	545.38	12.0	937.45

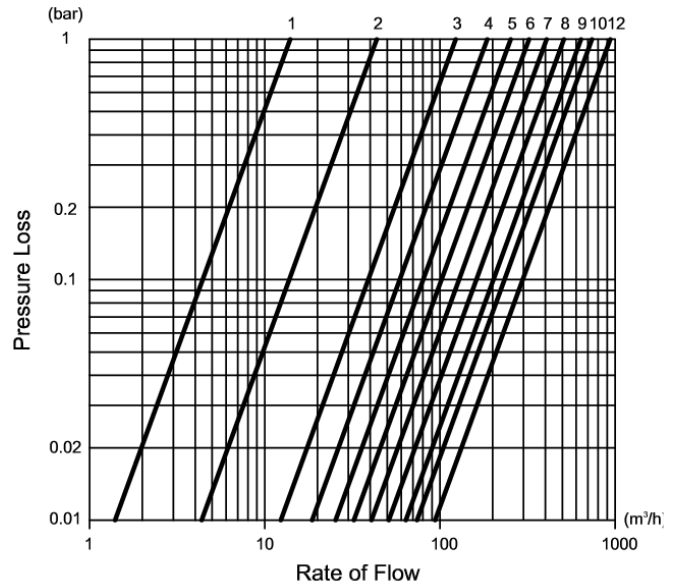
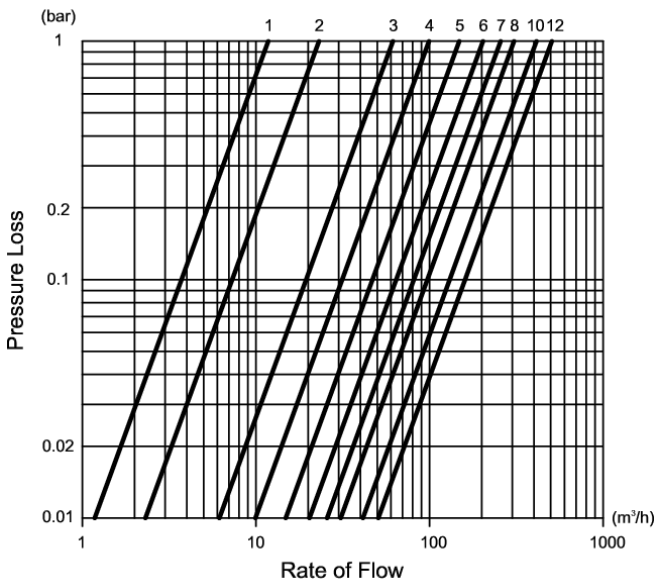

DN 300			
Presetting	Kv	Presetting	Kv
2	67.18	9.5	612.74
2.5	95.40	10	668.98
3	124.17	10.5	715.91
3.5	150.59	11	767.62
4	176.90	11.5	827.77
4.5	206.50	12	891.67
5	229.97	12.5	949.58
5.5	256.94	13	1007.44
6	287.48	13.5	1053.99
6.5	326.01	14	1099.25
7	369.65	14.5	1152.13
7.5	417.29	15	1194.78
8	468.33	15.5	1234.64
8.5	515.07	16	1275.89
9	560.51		

DN 350			
Presetting	Kv	Presetting	Kv
2	125.7	9.5	850.0
2.5	174.0	10	930.0
3	212.1	10.5	1005.0
3.5	248.6	11	1081.0
4	287.3	11.5	1162.4
4.5	329.0	12	1218.2
5	369.0	12.5	1273.6
5.5	407.6	13	1341.6
6	452.0	13.5	1406.5
6.5	491.6	14	1454.1
7	540.6	14.5	1528.1
7.5	588.8	15	1589.8
8	650.0	15.5	1663.3
8.5	712.0	16	1721.1
9	780.0		

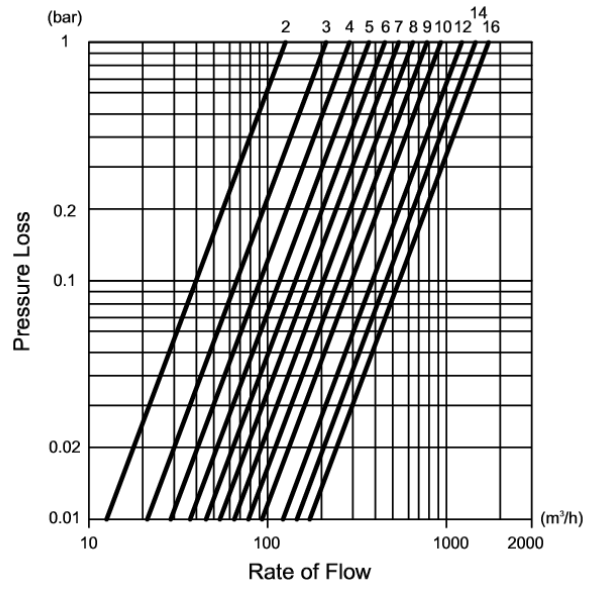
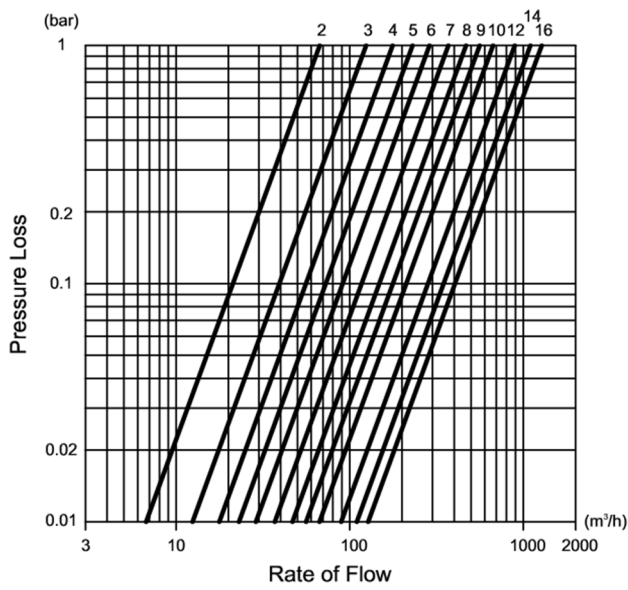

DN 400			
Presetting	Kv	Presetting	Kv
3	232.9	12	1447.8
3.5	248.1	12.5	1560.8
4	266.9	13	1673.7
4.5	281.5	13.5	1768.1
5	303.3	14	1866.9
5.5	316.8	14.5	1980.5
6	350.7	15	2076.6
6.5	386.0	15.5	2176.4
7	423.2	16	2254.7
7.5	503.7	16.5	2347.4
8	577.8	17	2427.4
8.5	651.1	17.5	2506.1
9	753.2	18	2571.6
9.5	843.3	18.5	2652.6
10	923.4	19	2703.6
10.5	1050.5	19.5	2763.7
11	1203.3	20	2790.3
11.5	1328.0		

DN 450			
Presetting	Kv	Presetting	Kv
3	163.5	12	1312.0
3.5	165.1	12.5	1460.0
4	168.2	13	1615.0
4.5	178.2	13.5	1728.2
5	190.1	14	1917.8
5.5	206.4	14.5	2100.7
6	228.0	15	2262.5
6.5	252.0	15.5	2451.7
7	290.5	16	2599.1
7.5	346.5	16.5	2743.4
8	408.0	17	2845.3
8.5	485.5	17.5	2981.5
9	577.2	18	3160.0
9.5	675.0	18.5	3260.0
10	788.0	19	3407.6
10.5	912.0	19.5	3490.6
11	1036.0	20	3569.3
11.5	1170.0		

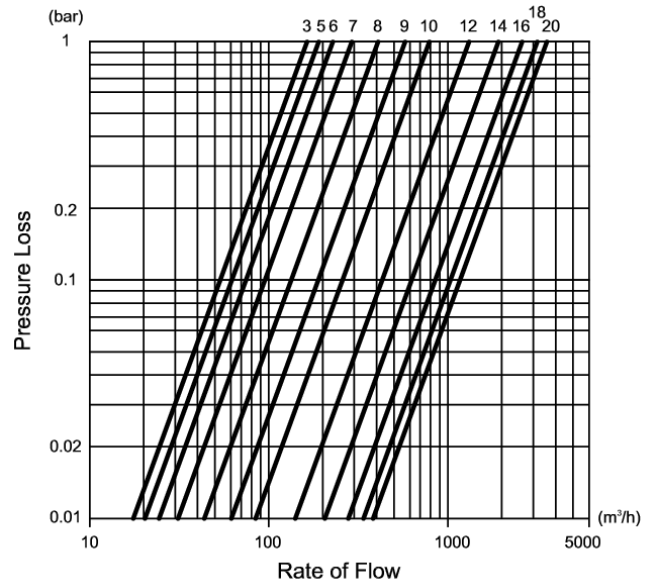
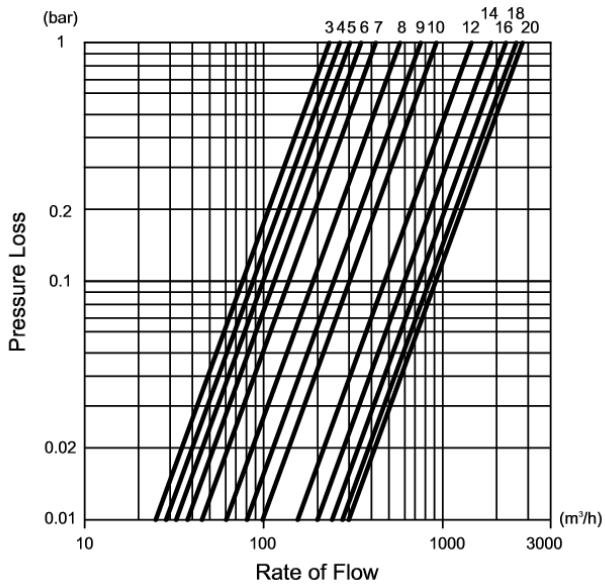

DN 500			
Presetting	Kv	Presetting	Kv
3	175.6	14	2100.0
3.5	182.5	14.5	2315.0
4	189.0	15	2505.0
4.5	205.0	15.5	2690.0
5	215.0	16	2818.0
5.5	234.0	16.5	2966.0
6	255.0	17	3100.0
6.5	280.0	17.5	3165.0
7	323.0	18	3215.0
7.5	390.0	18.5	3260.0
8	450.0	19	3312.0
8.5	550.0	19.5	3375.0
9	650.0	20	3418.0
9.5	760.0	20.5	3480.0
10	890.0	21	3545.0
10.5	1030.0	21.5	3616.0
11	1170.0	22	3680.0
11.5	1320.0	22.5	3745.0
12	1480.0	23	3790.0
12.5	1650.0	23.5	3835.0
13	1790.0	24	3885.0
13.5	1930.0		

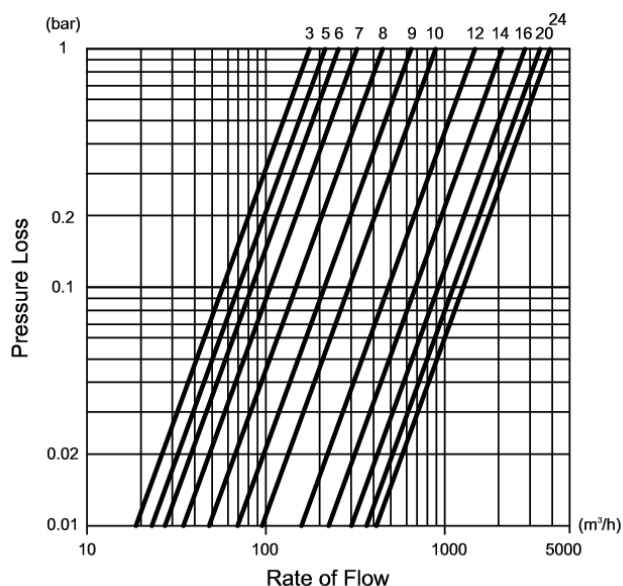

Installation Position

The Hydraulic Balancing valve should be possibly installed at the section of the straight pipe to stabilize the flow through the valve and to ensure the accurate measurement since the Valve has the function of measuring the rate of flow. Avoid installing the valve at the side of water supply, pump outlet and the position of turbulent flow.

Recommendation :

The distance between the curved pipe and the branch pipe is at least over 5D and 2D.

The distance between the pump outlet and the branch pipe is at least over 10D and 2D.

※D is the caliber of the Balancing Valve

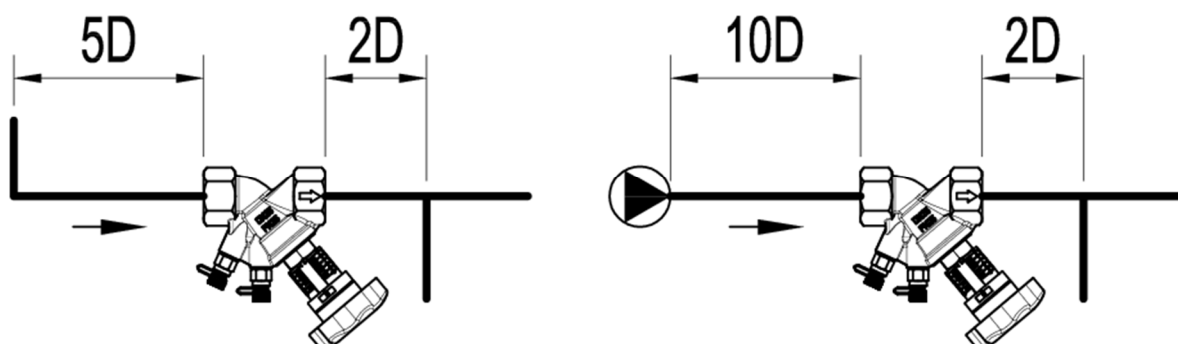

King-tech Valve Precision Industry Inc.



www.kingtech-sb.com

E-mail: sb.wow@msa.hinet.net

1F, No. 47, Lane 127, sect 2, North Xinsheng Road Taipei



Distributor